

# SMOKE DETECTOR INSTALLATION REQUIREMENTS & SPECIFIC LOCATIONS

Smoke detectors must be installed in accordance with and meet the requirements of National Fire Protection Association Standard (NFPA) 74 or its successors

- DO NOT install smoke detectors in kitchens, garages or other spaces where the temperature can fall below 32 degrees F or exceed 100 degrees F
- DO NOT locate smoke detectors closer than 3 feet from a door to a kitchen, bathroom with a tub or shower, or supply registers of a forced air heating or cooling system
- Smoke detectors must be on each level of the unit including basements
- If installed to protect a basement, the smoke detector must be on the ceiling at the bottom of the stairway leading to the floor above.
- If the unit is occupied by a hearing impaired individual, a smoke detector must be installed in the bedroom and have a visible signal.

## UNITS WITH BEDROOMS GROUPED TOGETHER    UNITS WITH SEPARATED SLEEPING AREAS

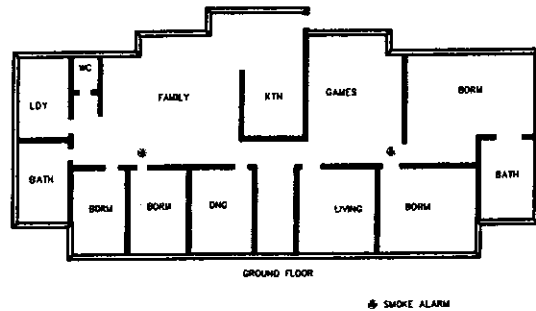
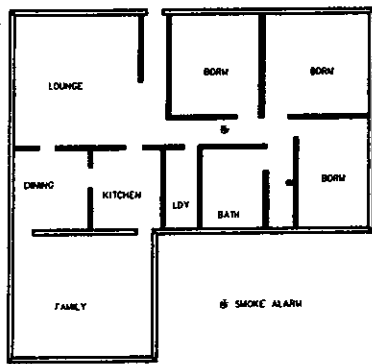

- Smoke detectors must be outside of the sleeping room but in the immediate vicinity of the sleeping room(s) when installed to protect a sleeping room(s)

## NEW CONSTRUCTION

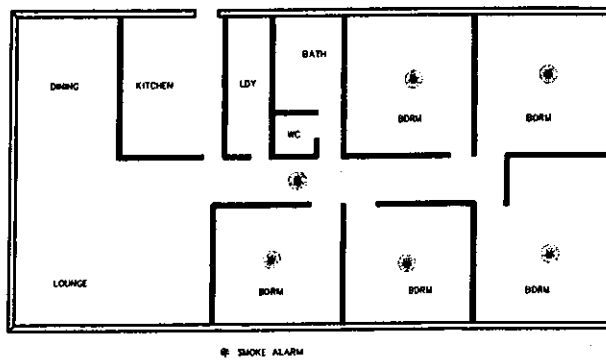

- If the unit was built after June 1, 2002, a smoke detector must be in every sleeping room.

## OPEN-JOISTED CEILING

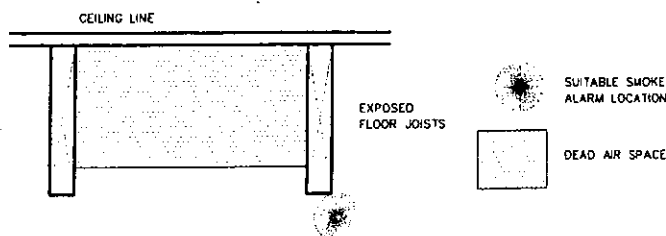

- If installed in an area with an open-joisted ceiling, the smoke detector must be installed on the bottom of the joist

## FLAT CEILINGS & WALLS

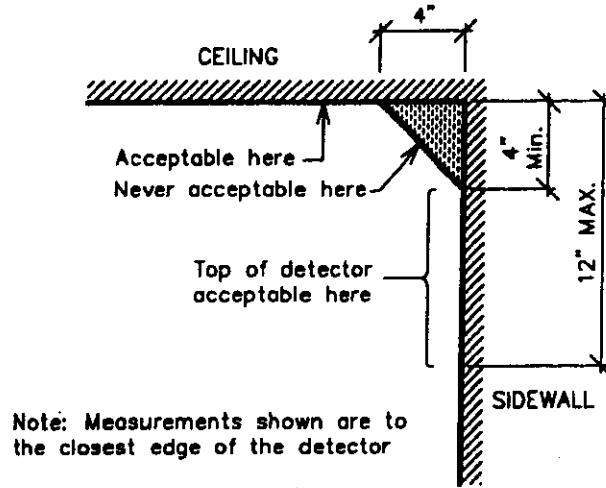

- For rooms with flat ceilings and walls smoke detectors must be:
  - Mounted on the ceiling at least 4 inches from a wall OR
  - On a wall with the top of the detector not less than 4 inches nor more than 12 inches below the ceiling

## PEAKED CEILINGS

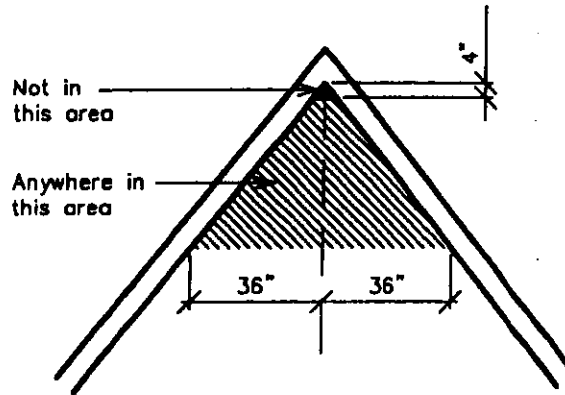

- For rooms with peaked sloping ceilings with a slope smoke alarms must be mounted on the ceiling within 3 feet, measured horizontally, from the peak of the ceiling; at least 4 inches, measured vertically, below the peak of the ceiling; and at least 4 inches from any projecting structural element.

## SHED SLOPING CEILINGS

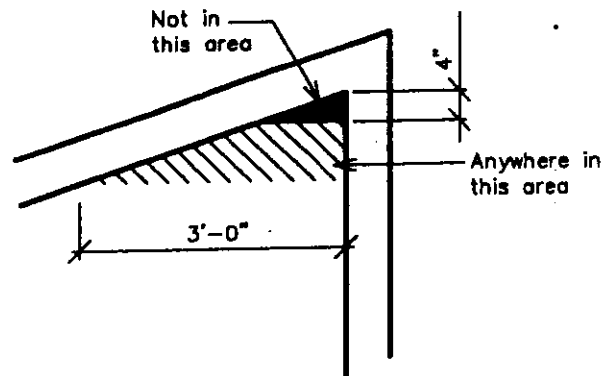

- For rooms with shed sloping ceilings smoke alarms must be mounted on the ceiling within 3 feet, measured horizontally, of the high side of the ceiling, and not closer than 4 inches from any adjoining wall surface and from any projecting structural element.